

# Model 854 Electric Switch Lock

## Description:

The Model 854 Electric Switch Lock is used to securely lock the hand-throw lever of a hand-operated switch machine or ground-throw switch stand in the normal position. It provides a means of interlocking a manually operated switch with the signal circuits so that the switch may not be operated unless traffic conditions permit, or unless the normally-sealed emergency release is operated. This switch lock may be applied to either a right or left hand layout.



## Features:

- Eliminates the need for tie dapping
- Single Color or bicolor LED indication light
- Emergency Release
- Silver-to-Silver contacts available in two arrangements
- Self-Lubricated bearings
- Abrasive resistant sight glass protects LED indication light
- Used with 3/4" to 1" thick by 2" wide hand throw lever

The Model 854 Switch Lock has a durable cast- construction. The relay is designed to operate at 100 ohms on 8 to 12V dc. If AC operation is required, a transformer and rectifier are required in separate housings.

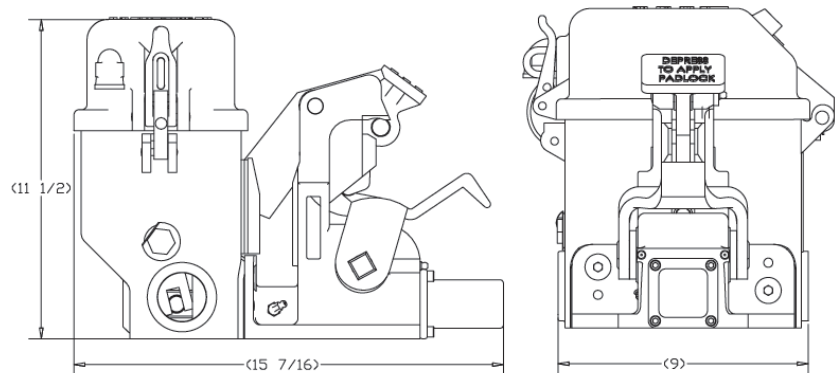

# Model 854 Electric Switch Lock

## Ordering Information:

Description	Contact Arrangement	Part Number
Model 854 Lock, with emergency release & single colored LED	Figure 1	854602-001-01
Model 854 Lock, with emergency release & single colored LED	Figure 1	854602-001-02
Model 854 Lock, with single colored LED, no emergency release	Figure 1	854603-001-01
Model 854 Lock, with single colored LED, no emergency release	Figure 1	854603-001-02
Model 854 Lock, with emergency release & bi-colored LED	Figure 1	854600-001-01
Model 854 Lock, with emergency release & bi-colored LED	Figure 1	854600-001-02
Model 854 Lock, with no emergency release & bi-colored LED	Figure 1	854601-001-01
Model 854 Lock, with no emergency release & bi-colored LED	Figure 1	854601-001-02

## Model 854 Contact Arrangements

The contact arrangements available with the Model 854 Switch Lock are shown with the lock in the normal position. Contacts 1 and 5 are actuated by the energizing of the lock-magnet coils. Contacts 2, 3, and 4 are actuated, whenever the padlock is removed.

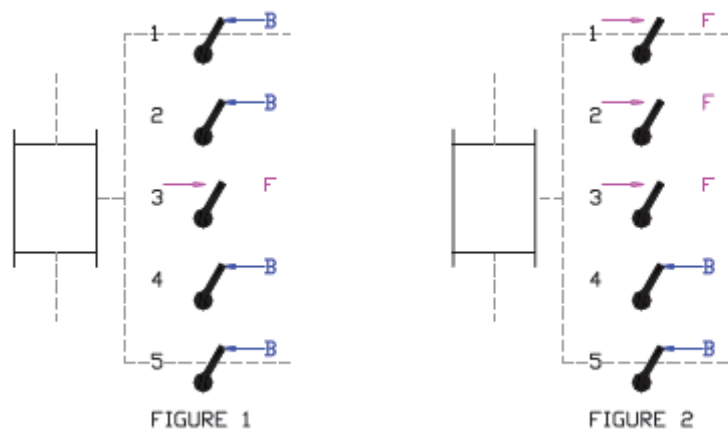

G&B Specialties  
P.O. Box 305  
535 West Third Street  
Berwick, PA 18603  
570-752-5901  
[www.gandbspecialties.com](http://www.gandbspecialties.com)

 **G&B Specialties**  
A Wabtec subsidiary