

PROPERTY DAMAGE, SEVERE INJURY AND/OR DEATH COULD RESULT FROM:

(1) FAILING TO FOLLOW THE INSTRUCTIONS CONTAINED IN THIS MAINTENANCE MANUAL;

OR

(2) REPAIRING, MODIFYING OR ALTERING ANY BARBER/SCT PRODUCT IN A MANNER THAT IS NOT INCLUDED IN THIS MAINTENANCE MANUAL.

IF YOUR SPECIFIC APPLICATION:

(1) REQUIRES A DEVIATION FROM THE INSTRUCTIONS CONTAINED IN THIS MAINTENANCE MANUAL;

(2) REQUIRES A REPAIR, MODIFICATION OR ALTERATION OF A BARBER/SCT PRODUCT THAT IS NOT INCLUDED IN THIS MAINTENANCE MANUAL;

OR

(3) RAISES ANY QUESTION ABOUT THE INSTRUCTIONS SPECIFIED IN THIS MAINTENANCE MANUAL,

PLEASE CONTACT YOUR BARBER/SCT REPRESENTATIVE FOR SPECIFIC INSTRUCTIONS REGARDING YOUR APPLICATION.

TO CONTACT YOUR BARBER/SCT REPRESENTATIVE:

PLEASE SEE THE "STANDARD CAR TRUCK COMPANY CONTACT INFORMATION" PAGE AT THE START OF THE FULL MANUAL.

Section 6

Gages

- Friction Wedge Condemning Gages
- Split Wedge Condemning Gages
- Stabilizer Wear Gages
- Side Frame Column Gages
- Bolster Pocket Slopewall Gages
- Bolster Pocket Sidewall Gages
- Bolster Gib and Land Gages
- Bolster Pocket Split Wedge Insert Condemning Gages
- Bolster Pocket Split Wedge Insert Centering Gages
- Bolster Pocket Split Wedge Insert Elevation Gages
- Bolster Pocket Wear Plate Installation Clamp

Standard Car Truck Company does not sell gages.
To purchase gages contact:

Winchester Industries, Inc.
(860) 379-5336

or

Victoria Mechanical Services, Inc.
(361) 578-7700

Always Use Original
Barber Parts



Standard Car Truck Company

865 Busse Highway, Park Ridge, Illinois 60068, U.S.A.
Telephone: 847-692-6050 Fax: 847-692-6299

Not A
Controlled
Document

Friction Wedge Condemning Gages

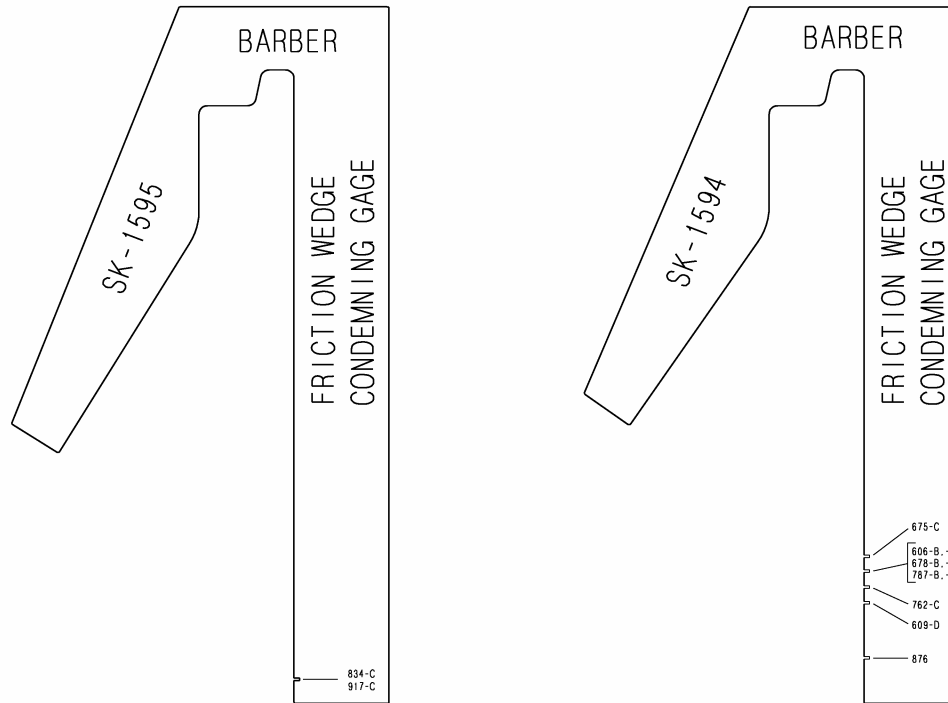

Truck Type	Iron Wedge	LifeGuard Wedge	TwinGuard Wedge	Condemning Gage Part Number	Marking on Gage Slot To Check Wedge
S-2-A	606-C	-	-	SK-1594	606-B, -C
	609-D	913-LG	-	SK-1594	609-D
S-2-B, S-2-C	675-C	-	922-PC	SK-1594	675-C
	678-C	-	-	SK-1594	678-B, -C
S-2-A, S-2-B, S-2-C	762-C	-	-	SK-1594	762-C
S-2-B, S-2-C	787-C	888-LG	911-PC	SK-1594	787-B, -C
S-2-HD, S-2-HD-9C	834-CB	950-LG	916-PC	SK-1595	834-C
S-2-D	876	877-LG	921-PC	SK-1594	876
S-2-E	917-C	-	-	SK-1595	917-C

Refer to section 2-A for application of gages.

Always Use Original
Barber Parts



Standard Car Truck Company

865 Busse Highway, Park Ridge, Illinois 60068, U.S.A.
Telephone: 847-692-6050 Fax: 847-692-6299

Not A
Controlled
Document

Split Wedge Condemning Gages

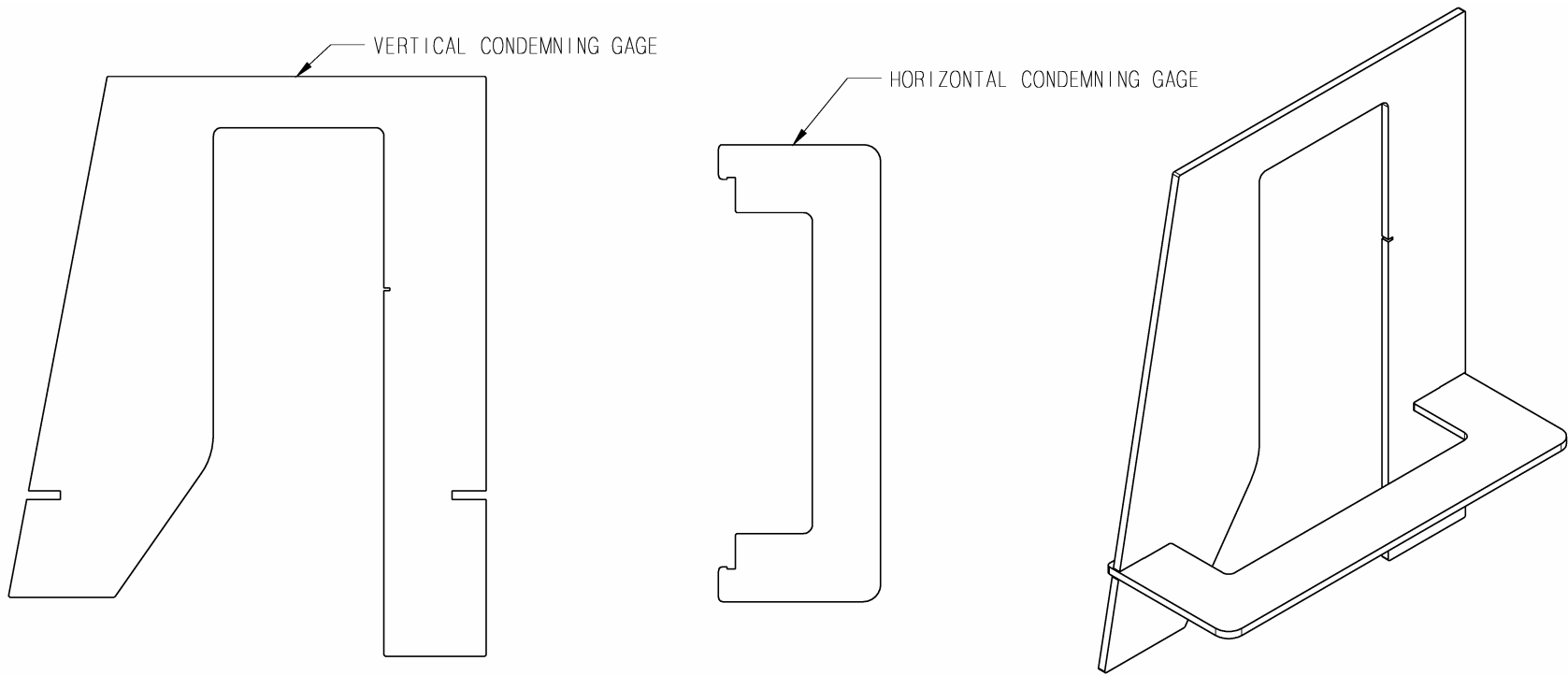

Truck Type	Split Wedge	Vertical Condemning Gage Part Number	Horizontal Condemning Gage Part Number
S-2-D	905-SW	SK-2054	SK-2046
S-2-HD, S-2-HD-9C	915-SW	SK-2050	SK-2046
S-2-B, S-2-C	925-SW	SK-2045	SK-2046
S-2-E	945-SW	SK-2062	SK-2063
S-2-A	955-SW	SK-2058	SK-2046

Refer to section 2-A for application of gages.

Always Use Original
Barber Parts



Standard Car Truck Company

865 Busse Highway, Park Ridge, Illinois 60068, U.S.A.
Telephone: 847-692-6050 Fax: 847-692-6299

Not A
Controlled
Document

Stabilizer Wear Gages

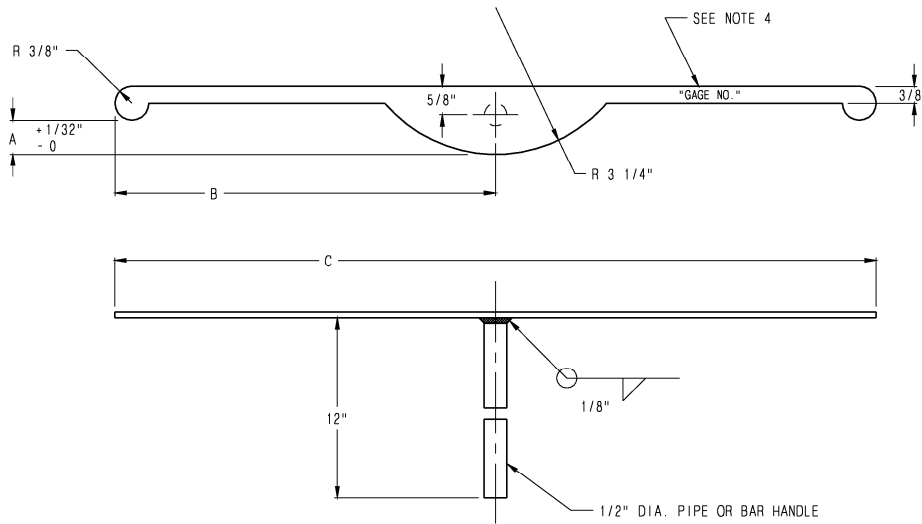

Stabilizer Wear Gage Table						
Gage No.	Bearing Size ³	AAR ¹ Spring Travel	Barber Friction Casting Part No.	Dim A	Dim B	Dim C
SK-1546-1	6 x 11	D-3	609-D, 955-SW, 913-LG ⁵	3/4	8 7/16	16 7/8
	6 x 11	D-4 or D-5	678-C, 678-B ² , 787-C, 787-B ² , 925-SW, 888-LG ⁵ , 911-PC			
	6 1/2 x 12	D-3	609-D, 955-SW, 913-LG ⁵			
	6 1/2 x 12	D-5	876, 905-SW, 877-LG, 921-PC, 834-CB, 915-SW, 950-LG, 916-PC, 917-C, 945-SW			
	6 1/2 x 12	D-7	876, 905-SW, 877-LG, 921-PC			
SK-1546-2	6 1/2 x 12	D-4 or D-5	787-C, 787-B ² , 925-SW, 888-LG ⁵ , 911-PC	1/2		
SK-1546-3	6 x 11 ⁴	D-4 or D-5	675-C	1 1/4	7 3/16	14 3/8
SK-1546-4	7 x 12	D-5 or D-6	834-CB, 915-SW, 950-LG, 916-PC	1/2	9 9/16	19 1/8
SK-1546-5	7 x 12	D-3 or D-4	762-C	1/4	10 3/32	20 3/16
SK-1546-6	7 x 12	D-5	762-C	3/4		

1. Standard A.A.R. spring groups for Barber S-2-A, S-2-B, S-2-C, S-2-D, S-2-HD, S-2-HD-9C, & S-2-E
2. Extended toe friction castings for Canada.
3. All 6 1/2 x 12 gages apply to 6 1/2 x 9.
4. Low conveyance application only.
5. Rest gage on top center for LifeGuard wedges without shoulders.

Refer to section 2-A for application of gages.

Always Use Original
Barber Parts



Standard Car Truck Company

865 Busse Highway, Park Ridge, Illinois 60068, U.S.A.
Telephone: 847-692-6050 Fax: 847-692-6299

Not A
Controlled
Document

Side Frame Column Gages

Truck Type	Capacity	Gage Number
S-2-A S-2-B S-2-C	50 Ton	SK-1503-1
	50 Ton Wide Land	
	70 Ton Low Conveyance	
	70 Ton	SK-1503-4
	100 Ton	
	70 Ton Wide Land	
100 Ton Wide Land		
	100 Ton Combination	
	125 Ton	SK-1560-1
S-2-D S-2-HD-9C	100 Ton	SK-1503-7
S-2-HD	100 Ton	SK-1432
	125 Ton	SK-1560-2
S-2-E	70 Ton	SK-2265
	100 Ton	SK-2524

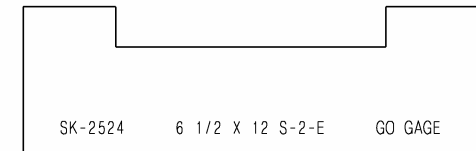
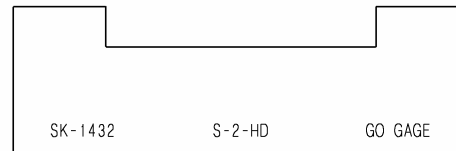
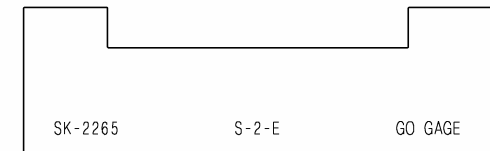
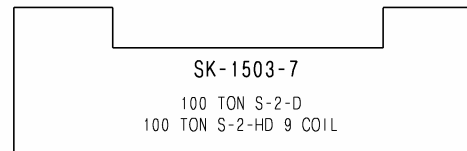
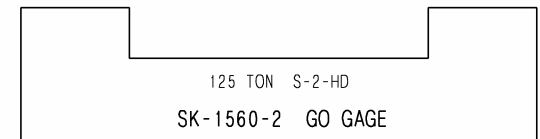
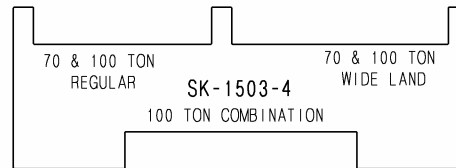
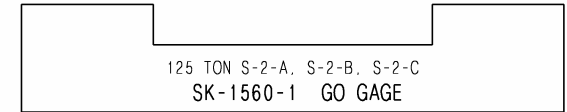
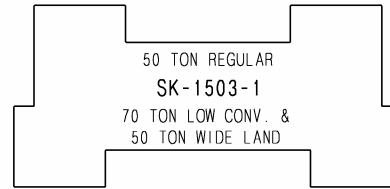

Refer to section 4-A for application of gages.

Bolster Pocket Slopewall Gages

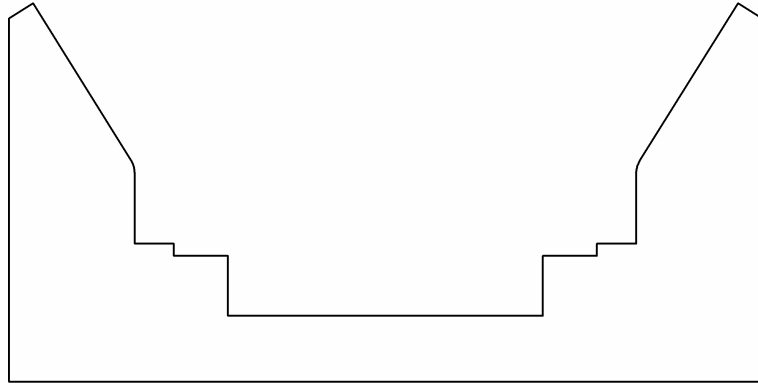

SK-1689-X

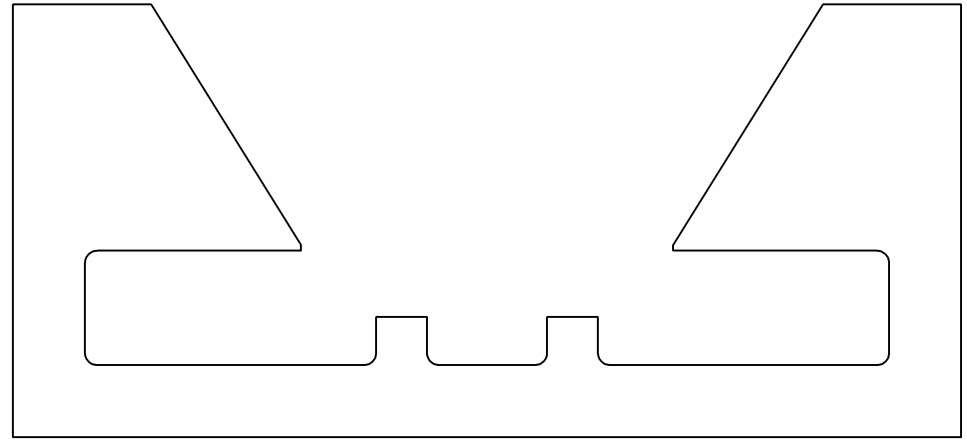

SK-2527-X

Gage No.	Truck Type	Bearing Size**	Wear Plate Part No.	Wear Plate Drawing
SK-1689-1	S-2-A	5 x 9	271	5299
SK-1689-2	S-2-A	5 1/2 x 10	272	5299
SK-1689-3	S-2-A	6 x 11 6 1/2 x 12	273	5299
SK-1689-4	S-2-A S-2-C	7 x 12	274	5299
SK-1689-5	S-2-C	5 x 9 5 1/2 x 10	272	5299
SK-1689-6	S-2-C	6 x 11 6 1/2 x 12	273	5299
SK-1689-7	S-2-HD	6 x 11 6 1/2 x 12	276	5299
SK-1689-8	S-2-D	6 1/2 x 12	-	-
SK-1689-9	S-2-HD	7 x 12	276	5299
SK-1689-10	S-2-B*	6 x 11	281	5299
SK-1689-11	S-2-HD-9C	6 1/2 x 12	276	5299
SK-2527-1	S-2-E	6 1/2 x 12	279	5299
SK-2527-2	S-2-E	6 x 11	279	5299

* Low conveyance truck with D-4 springs. For all other S-2-B bolsters use S-2-C gages.

** All 6 1/2 x 12 gages apply to 6 1/2 x 9.

Refer to section 5-A for application of gages checking for wear. Refer to section 5-C for application of gages checking a restored bolster pocket.

Always Use Original
Barber Parts



Standard Car Truck Company

865 Busse Highway, Park Ridge, Illinois 60068, U.S.A.
Telephone: 847-692-6050 Fax: 847-692-6299

Not A
Controlled
Document

Bolster Pocket Sidewall Gages

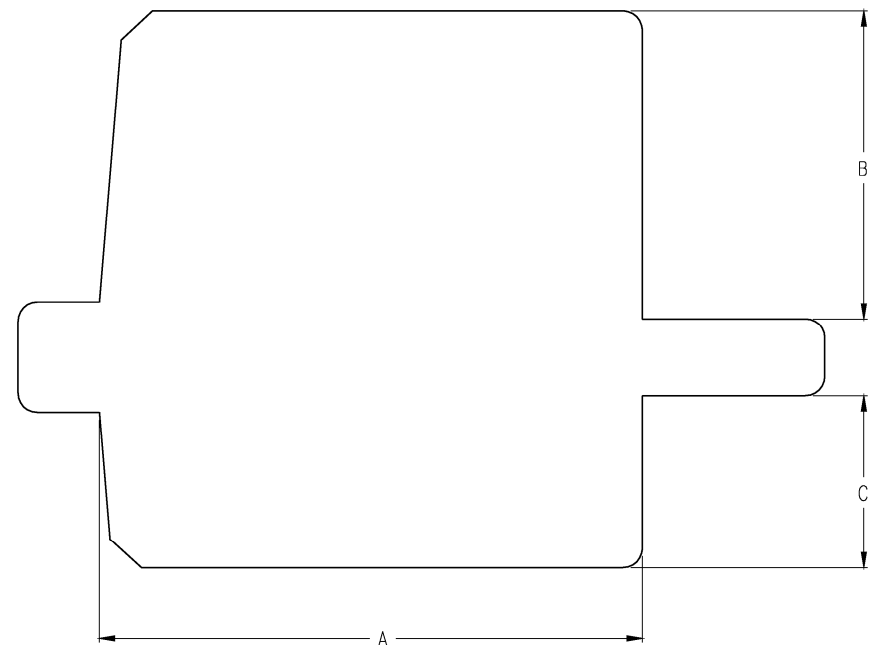
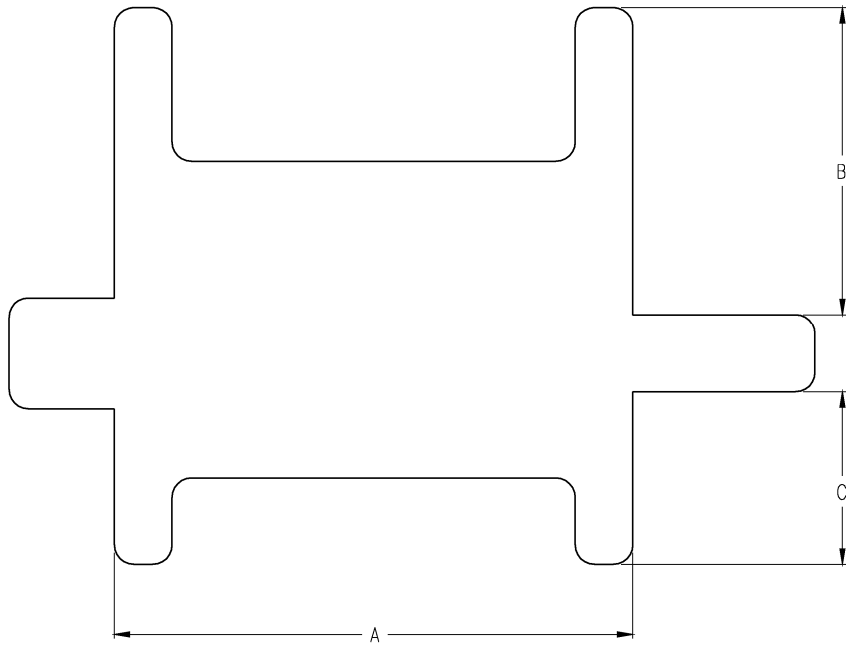

Straight Wall Application*					
Gage No.	Capacity †	Truck Type	A	B	C
SK-2546-1	70 Ton 100 Ton	S-2-A	5.75	3.50	1.00
		S-2-B			
		S-2-C			
SK-2546-2	100 Ton	S-2-D	7.25	4.00	2.25
SK-2546-3	100 Ton	S-2-HD	6.75	4.00	2.25
SK-2546-4	100 Ton	S-2-HD-9C	6.75	4.00	2.25
SK-2546-5	125 Ton	S-2-HD	6.75	3.25	1.50
SK-2546-6	125 Ton	S-2-A	6.75	2.50	1.00
		S-2-C			
SK-2546-7	50 Ton	S-2-A	5.25	3.25	1.50
		S-2-B			
		S-2-C			
SK-2548	70 Ton 100 Ton	S-2-E	8.75	3.75	2.11

Angled Wall Application*					
Gage No.	Capacity †	Truck Type	A	B	C
SK-2547-1	100 Ton	S-2-D	7.59	4.00	2.25
SK-2547-2	100 Ton	S-2-HD	7.06	4.00	2.25
SK-2547-3	100 Ton	S-2-HD-9C	7.06	4.00	2.25
SK-2547-4	125 Ton	S-2-HD	7.06	3.25	1.50

* Suitable for bolsters that are designed with an angled outboard pocket sidewall, for use with single piece iron wedges only

† 100 Ton gages also apply to 110 Ton.

* Suitable for squaring bolster pocket sidewalls or bolsters designed with square pocket sidewalls, for use with all wedges.

† 100 Ton gages also apply to 110 Ton.

Refer to section 5-A for application of gages checking for wear. Refer to section 5-C for application of gages checking a restored bolster pocket.

Always Use Original
Barber Parts



Standard Car Truck Company

865 Busse Highway, Park Ridge, Illinois 60068, U.S.A.
Telephone: 847-692-6050 Fax: 847-692-6299

Not A
Controlled
Document

Bolster Gib and Land Gages

Gage No.	Truck Type	Capacity†	A	B
SK-1504-1	Regular Barber	40 & 50 Ton	.625	6.500
SK-1504-8	Wide Land	40 Ton	1.375	7.500
SK-1504-9	Wide Land	50 Ton	1.375	8.000
SK-1504-11	S-2-HD	100 Ton	2.625	11.000
SK-1504-12	S-2-HD	125 Ton	2.500	12.125
SK-1504-13	S-2-D	100 Ton	2.500	10.875
SK-2264-1	S-2-E	70 Ton	1.375	11.500
SK-2264-2	S-2-E	100 Ton	1.625	12.000
Bolsters made in 1987 or later				
SK-1504-2A	Regular Barber	70 & 100 Ton	.875	7.500
SK-1504-3A	Regular Barber	125 Ton	2.250	11.125
SK-1504-4A	Low Conveyance With D-4 Springs	70 Ton	1.625	8.500
SK-1504-5A	Low Conveyance With D-5 Springs	70 Ton	1.625	9.000
SK-1504-6A	Combination	100 Ton	1.875	9.500
SK-1504-7A	Low Profile Combination	100 Ton	1.875	9.500
SK-1504-10A	Wide Land	70 & 100 Ton	1.625	9.000
Bolsters made before 1987				
SK-1504-2B	Regular Barber	70 & 100 Ton	.625	7.375
SK-1504-3B	Regular Barber	125 Ton	2.000	11.125
SK-1504-4B	Low Conveyance With D-4 Springs	70 Ton	1.375	8.375
SK-1504-5B	Low Conveyance With D-5 Springs	70 Ton	1.375	8.875
SK-1504-6B	Combination	100 Ton	1.625	9.375
SK-1504-7B	Low Profile Combination	100 Ton	1.625	9.375
SK-1504-10B	Wide Land	70 & 100 Ton	1.375	8.875

† 100 Ton gages also apply to 110 Ton.

Refer to section 5-A for application of gages checking for wear. Refer to section 5-C for application of gages checking a restored bolster pocket.

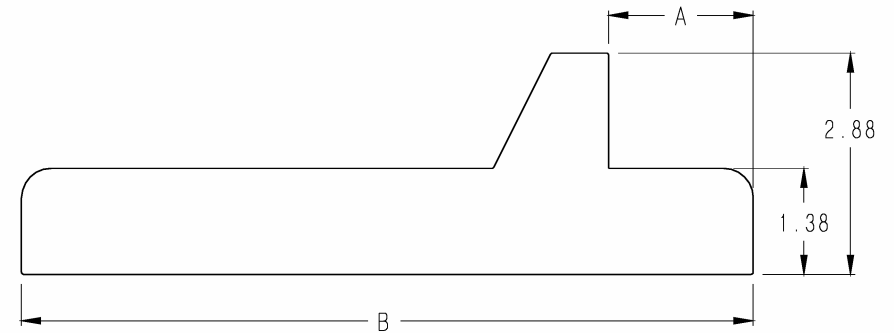

SK-1504-X

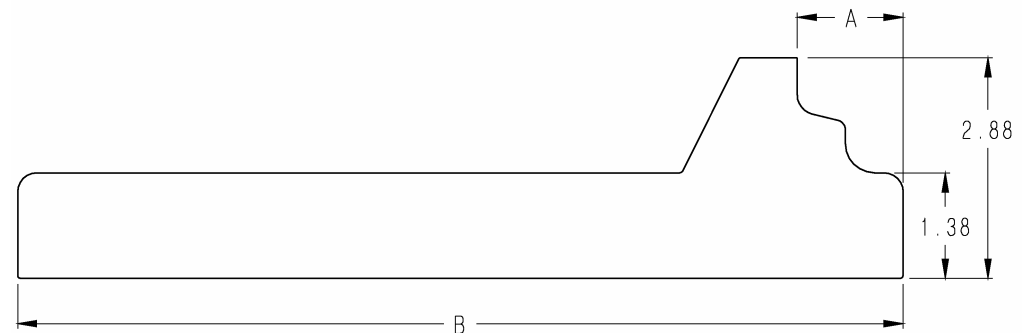

SK-2264-X

Bolster Pocket Split Wedge Insert Condemning Gages

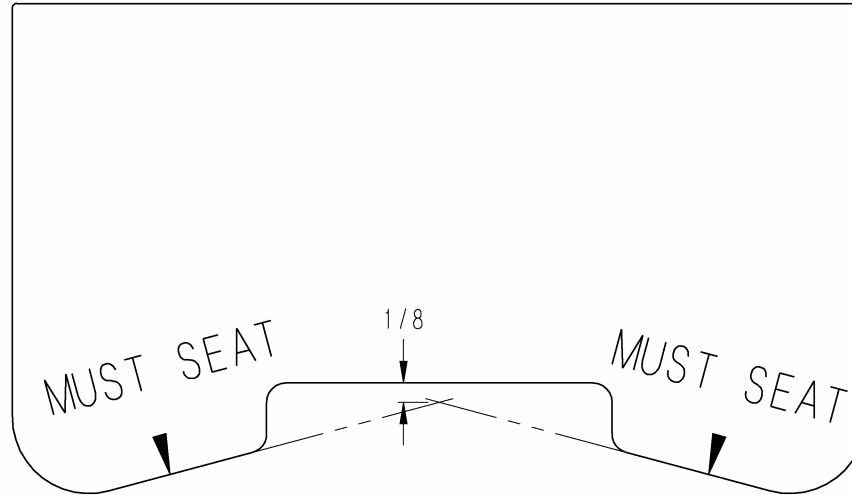

Truck Type	Wedge	Insert	Condemning Gage No.
S-2-A	955-SW	5824 5286*	SK-2048
S-2-B S-2-C	925-SW	5824 5286*	SK-2048
S-2-D	905-SW	5902	SK-2056
S-2-HD S-2-HD-9C	915-SW	5821	SK-2052
S-2-E	945-SW	6022	SK-2065

* Insert is used in "as cast" bolster pockets (pockets designed not to use pocket wear plates).

Refer to section 5-A for application of gages.

Bolster Pocket Split Wedge Insert Centering Gages

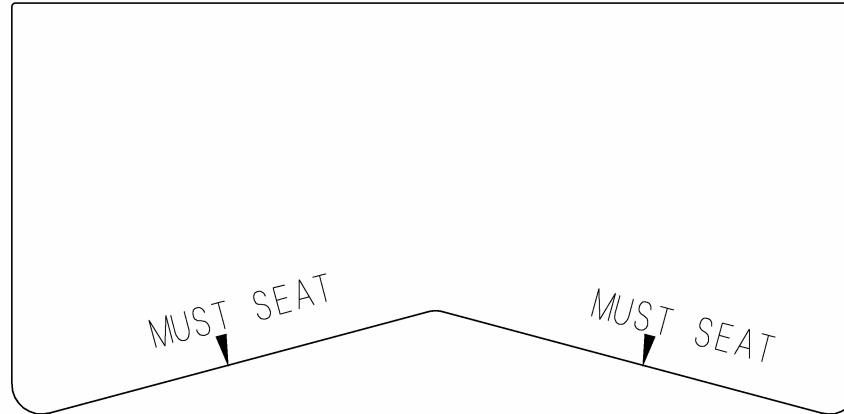

Truck Type	Wedge	Insert	Centering Gage No.
S-2-A	955-SW	5824 5286*	SK-2014
S-2-B S-2-C	925-SW	5824 5286*	SK-2014
S-2-D	905-SW	5902	SK-1777
S-2-HD S-2-HD-9C	915-SW	5821	SK-1755
S-2-E	945-SW	6022	SK-2041

* Insert is used in "as cast" bolster pockets (pockets not designed to use pocket wear plates).

Refer to section 5-C for application of gages.

Bolster Pocket Split Wedge Insert Elevation Gages



Capacity†	Truck Type	Wedge	Insert	Elevation Gage No.
70 Ton 100 Ton	S-2-A	955-SW	5824 5286*	SK-2033
70 Ton 100 Ton	S-2-B S-2-C	925-SW	5824 5286*	SK-2013
100 Ton	S-2-D	905-SW	5902	SK-1776
100 Ton	S-2-HD S-2-HD-9C	915-SW	5821	SK-1754-1
125 Ton	S-2-HD	915-SW	5821	SK-1754-2
70 Ton 100 Ton	S-2-E	945-SW	6022	SK-2042

* Insert is used in "as cast" bolster pockets (pockets not designed to use pocket wear plates).

† 100 Ton gages also apply to 110 Ton.

Refer to section 5-C for application of gages.

